

USE AND CARE OF YOUR

**BUNN**<sup>®</sup>

My Café<sup>®</sup>

## Tea & Coffee Pod Brewer

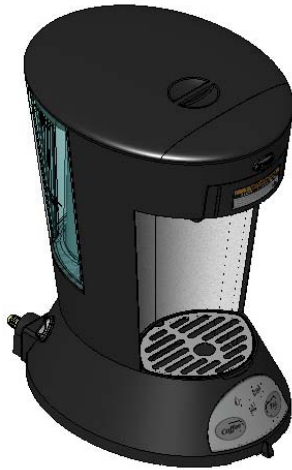

**Model MCA**

AUTOMATIC



**Model MCP**

POUR IN

*The Bunn logo is a registered trademark of Bunn-O-Matic Corporation.  
My Café is a registered trademark of Bunn-O-Matic Corporation.*

### **RECORD MODEL & SERIAL NUMBER**

*In order to receive accurate and timely warranty assistance, it is important to record the Model and Serial Number information located on the bottom of the brewer. A space is provided below for this information.*

MODEL: \_\_\_\_\_

SERIAL NUMBER: \_\_\_\_\_

*Record these numbers from the bottom of the brewer, before filling the brewer with water.*

## TABLE OF CONTENTS

WARNINGS .....	2
USER NOTICES .....	3
INTRODUCTION .....	3
IMPORTANT HANDLING INFORMATION .....	3
SPECIFICATIONS .....	4
IMPORTANT SAFEGUARDS .....	5
GENERAL INFORMATION .....	6
FEATURES AND CONTROLS .....	8
DEFINITIONS .....	9
WATER INLET SET-UP .....	10
PLUMBING REQUIREMENTS .....	10
INITIAL BREWER SET-UP .....	11
BREWING DELICIOUS COFFEE OR TEA .....	13
ROUTINE CLEANING .....	14
PERIODIC CLEANING/DESCALING .....	14
CLEANING THE SPRAYHEAD/SEAL .....	15
ASSEMBLING THE SPRAYHEAD/SEAL .....	15
INSPECTING THE SPRAYHEAD/SEAL .....	16
CLEANING THE POD HOLDER .....	16
CYCLING THE BREWER .....	16
STORING THE BREWER .....	16
TROUBLESHOOTING .....	17-19
LIMITED WARRANTY .....	20
USER SERVICEABLE PARTS .....	22



This symbol alerts you to the risk of fire or electrical shock in the accompanying message.



**Hazardous Voltage!**  
**Can Cause Fire Or Electrical Shock!**  
 Do Not Disassemble The Brewer!



This symbol alerts you to important operating and service instructions.

There Are No User Serviceable Parts Inside!  
 Repair Should Be Done By Authorized Service Personnel!  
**Keep this booklet for future reference.**

## USER NOTICES

Carefully read and follow all notices on the equipment and in this manual. They were written for your protection. All notices on the equipment should be kept in good condition. Replace any unreadable or damaged labels by visiting our web site at [www.bunn.com](http://www.bunn.com).

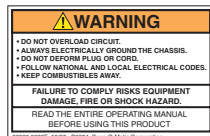

# 00986.0002



# 37267.0000



# 37280.0000



# 37281.0000

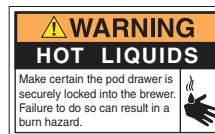

# 41936.0000



# 37282.0000

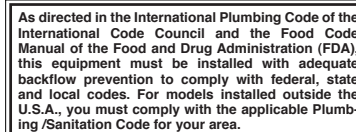

# 00656.0001

## INTRODUCTION

The BUNN® My Café® Automatic and Pourover Tea & Coffee Pod Brewer is designed to personalize your brewing experience by allowing a single cup brew of perfectly balanced coffee or tea.

BUNN® brewers are recognized in homes, offices and restaurants throughout the world as the very finest.

### IMPORTANT HANDLING INFORMATION

To avoid dropping and damaging the brewer or reservoir, do not attempt to pick the brewer up by the reservoir or lid. Always grasp the brewer by the sides, bottom, or top and bottom of the brewer.

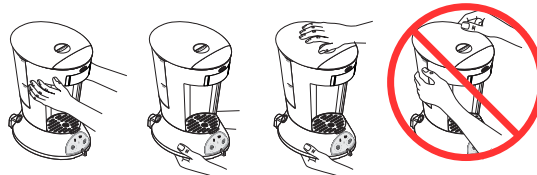

P3027

## **SPECIFICATIONS**

**Electrical** (MCA/MCP)- This brewer has an attached, 3-prong grounded cord set and requires 2-wire service with ground, rated 120 volts ac, 12 amps, single phase, 60 Hz. Components include a 1450-watt tank heater.

**NOTE:** *Do not operate brewer on the same outlet as other electrical appliances.*

**Electrical** (MCAA/MCPA)- This brewer has an attached, grounded cord set and requires 2-wire service with ground, rated 220-240 volts ac, 6 amps, single phase, 50/60 Hz. Components include a 1450-watt (max.) tank heater.

**NOTE:** *Do not operate brewer on the same outlet as other electrical appliances.*

## **CE REQUIREMENTS**

- This appliance must be installed in locations where it can be overseen by trained personnel.
- For proper operation, this appliance must be installed where the temperature is between 5°C to 35°C.
- Appliance shall not be tilted more than 10° for safe operation.
- An electrician must provide electrical service as specified in conformance with all local and national codes.
- This appliance must not be cleaned by water jet.
- This appliance is not intended for use by persons (including children) with reduced physical, sensory or mental capabilities, or lack of experience and knowledge, unless they have been given instructions concerning use of this appliance by a person responsible for its safety.
- Children should be supervised to ensure they do not play with the appliance.
- If the power cord is ever damaged, it must be replaced by the manufacturer or authorized service personnel with a special cord available from the manufacturer or its authorized service personnel in order to avoid a hazard.
- Machine must not be immersed for cleaning.

### **Dimensions:**

MCA/MCAA/MCPA - 13 <sup>9</sup>/<sub>16</sub> in. (34.4 cm) High; 7 <sup>13</sup>/<sub>16</sub> in. (19.8 cm) Wide; 11 <sup>1</sup>/<sub>16</sub> in. (28 cm) Deep.

MCP - 12 <sup>7</sup>/<sub>16</sub> in. (31.6 cm) High; 7 <sup>3</sup>/<sub>4</sub> in. (19.7 cm) Wide; 10 <sup>5</sup>/<sub>8</sub> in. (27 cm) Deep.

### **Brew Capacity:**

MCA/MCAA and MCP/MCPA - Approx. 4 to 12 oz. (118 to 355 ml) serving in one

## IMPORTANT SAFEGUARDS



Follow these basic safety precautions when using electrical appliances to reduce the risk of fire, electric shock, and/or personal injury:



- Read all instructions.
- Do not touch hot surfaces. Use handles or knobs.
- To protect against electric shock, do not place cord, plug, or brewer in water or liquid.
- Close supervision is necessary when the brewer is used by or near children.
- Unplug from outlet when not in use for extended periods of time and before cleaning. Allow to cool before putting on or taking off parts, and before cleaning.
- Do not operate the brewer with a damaged cord or plug, or after the brewer malfunctions or has been damaged in any manner. Return the brewer to an Authorized Service Facility for examination, adjustment, or repair.
- The use of an accessory not evaluated for use with this brewer may cause injuries and is not authorized.
- For indoor use only.
- Do not let the power cord hang over edge of table or counter, or touch hot surfaces.
- Do not place the brewer on or near a hot gas or electric burner, or in a heated oven.
- Do not use brewer for other than its intended use.
- Do not insert or remove pod holder while brewing. Press the coffee or tea button to stop or cancel a brew cycle.
- A canceled brew cycle is not held in memory. The next brew cycle will dispense full volume based on the volume setting.
- To avoid container overflow, empty mug before each brew cycle.
- Never place hands directly under the pod holder. Hot water and steam can be present.
- Do not place brewer in a sink or near other water source. Remove reservoir and fill separately or use the slide lid.
- When the brewer is idle, the lid should be in the closed position.
- Always use a mug or bowl that is larger than the brew volume selected.
- Keep hands away if container overflows. Wait until brew finishes, let liquid cool, then lower volume setting or use a larger mug.
- Never brew without the pod holder insert in place. Excessive pressure on the pod could result in coffee or tea escaping from the holder and into the container. Hot liquid splash and burns could occur.
- Use cold water only.
- Do not place torn pods or use ground coffee in pod holder.



## SAVE THESE INSTRUCTIONS



- A short power-supply cord is used to reduce the risks resulting from becoming entangled in or tripping over a longer cord.
- If an extension cord is used, the marked electrical rating of the extension cord should be at least as great as the electrical rating of the brewer, and the cord should be arranged so that it will not hang over the edge of the table or counter where it can be pulled on by children or tripped over.
- The extension cord must be of the 3-pronged, 3-socketed, grounding type, 3-wire cord. (Including grounding conductor).
- If the power cord is ever damaged, it must be replaced by the manufacturer or authorized service personnel with a special cord available from the manufacturer or its authorized service personnel in order to avoid a hazard. Improper electrical installation will damage electronic components. Damage caused by incorrect electrical connections is not covered by warranty.



### GENERAL INFORMATION

*Improper installation could result in permanent damage and void the limited warranty. Read & follow instructions on pages 10-11.*



- **Use CAUTION when dispensing hot water from the brewer. The water from your BUNN® Pod brewer is approximately 200°F (93°C). This is approximately 50°F (10°C) hotter than the hot water from your faucet and must be handled with care.**
- This brewer is designed to remain plugged in at all times (except during initial installation, cleaning, or when brewer will not be used for an extended period of time).
- A power switch is provided on the lower left side to completely shut off all electrical components when your plans take you away from the brewer for three or more days. Safety features, designed into the BUNN® Pod brewer, make the daily use of this switch unnecessary.
- Whenever the brewer has been shut off or unplugged for an extended period of time, rinse the reservoir and refill with fresh cold water before using. It is also recommended that the brewer be cycled. (See page 15)
- Your BUNN® Pod brewer has a specially designed tank to keep the water inside at the proper temperature. This constant supply of hot water assures the correct method of brewing in less than one minute.
- When inserting a pod into the pod holder, it is important to seat the pod all the way into the holder cavity. Leaks could occur if the pod is too large, or does not seat completely into the holder cavity. Ensure that all of the paper edge and any tabs of the pod are inserted into the holder cavity.
- Prior to brewing, make certain pod holder is securely locked into the brewer.  
**Failure to do so can result in a burn hazard.**
- While brewing, the incoming water in the tank is also being heated to the proper temperature and held until needed.
- The brewer is equipped with a 120 volt, 3-prong grounded cord set. The plug is provided with a round grounding pin. (International brewers are equipped with a 230 volt, grounded cord set. The plug is provided with a grounding circuit in compliance with local requirements) This is a safety feature and allows the plug to fit into a properly grounded outlet. If the plug does not fit into the outlet, contact an electrician to update your outlet. Attempting to bypass the safety aspect of this plug will void the warranty.
- The sprayhead may become loose over time. Unplug the machine and allow it to cool down before tightening or removing the sprayhead. Use extreme caution not to burn yourself. Tighten or remove the sprayhead with your fingertips.

**CONTINUED**

**GENERAL INFORMATION (Cont.)**

- **CAUTION:** Never apply force to remove the pod holder. If the holder does not slide out easily, wait 10 minutes and try again. Burns resulting from hot water splash could occur if the holder is forcibly removed from the brewer.
- Use **CAUTION** to avoid burns during consumption of any freshly brewed beverage. Servings are extremely hot.

## FEATURES & CONTROLS

- A** Slide Lid
- B** Pod Holder Release Button
- C** Sprayhead Seal
- D** Sprayhead
- E** Pod Holder Insert
- F** Pod Holder
- G** Drip Tray Grate
- H** Drip Tray
- I** Volume Control Lever
- J** Control Panel
- K** Brew Lights (Blue)
- L** Water Inlet (MCA)
- M** Power Switch
- N** Water Reservoir
- O** Primer Bulb

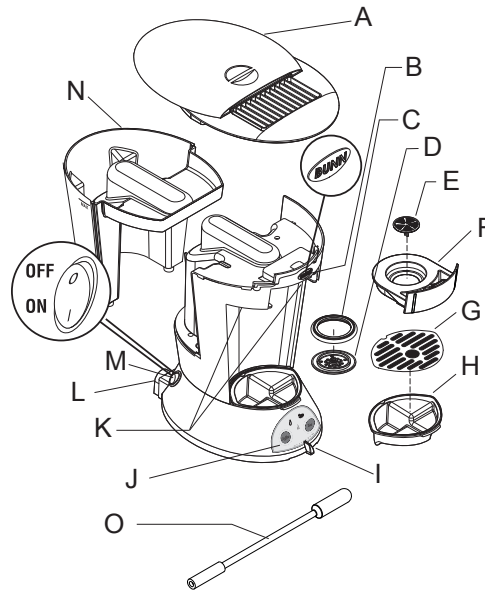

**WARNING:** Hot liquids present. Use caution when brewing and removing the Pod Holder.

**NOTE:** Brewer requires a minimum 15 amp circuit.

## CONTROL PANEL

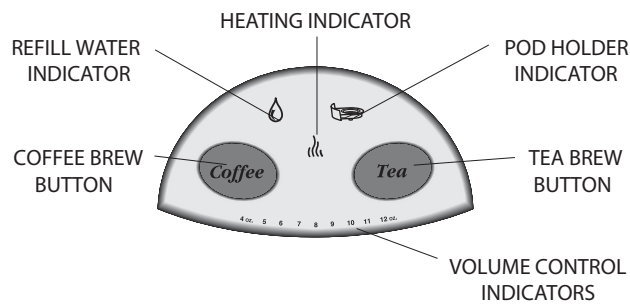



## DEFINITIONS

- **SLEEP MODE** - If the brewer has been idle for 6 hours, it will reduce power to conserve energy. After 26 hours, the brewer will shut down completely. When either of these two sleep modes occur, the Pod Holder Release Button will no longer be glowing red. To wake the brewer up, press either the Coffee or Tea Brew button, or eject the pod holder. The light and heater will come back on.
- **BREW CANCEL** - If it is necessary to cancel a brew cycle, this can be done by pressing either the Coffee or Tea button again. Although some water may drip out, the pump will immediately stop forcing water through the pod holder. Always wait for hot liquid to stop before removing the pod holder.

**CAUTION:** *When a brew cycle is canceled, it will not finish dispensing its previous brew volume when the button is pressed again. The memory is reset and the brewer will dispense a full volume as indicated by the Volume Control Lever. This could cause a container to overflow if it is not emptied prior to pressing the button a second time.*

- **MIN & MAX MARKINGS** - The side of the water reservoir bears the markings "MIN" and "MAX". These markings indicate the minimum and maximum amount of water that can be placed in the reservoir. If the minimum amount of water is not in the reservoir, the brewer will not operate. These markings are referenced throughout this booklet.
- **PULSE BREW™** - Using the Tea Button will cause the brewer to perform a pulse brew operation. A Pulse Brew cycles the water on and off to effectively steep the tea to extract the proper flavor. The "On-Off-On" water flow is normal. Always wait for the blue (brew) lights to go out, and the red BUNN light to come back on before carefully removing the mug or pod holder. Pressing either brew button during this operation will stop the brew cycle. (See the "Brew Cancel" feature above for more information.)

### WATER INLET SET-UP (MCA/MCAA ONLY)

The My Café® Automatic Pod Brewer is designed for businesses and office applications, where a pressurized water system can be utilized to feed the brewer with a constant water supply. If the machine will not be used with plumbing, follow MCP/MCPA set up instructions.

**IMPORTANT NOTE:** If the brewer is to be used as a pour-over, the cap must be installed on the water inlet fitting, located in the rear of the brewer. (See FIG. 3) Otherwise, prepare the existing water line as defined in "Plumbing Requirements" and then follow the instructions provided below.

### PLUMBING REQUIREMENTS

If used as an automatic, this brewer must be connected to a cold water system with operating pressure between 20 and 90 psi (138 and 620 kPa) from a 1/2" or larger supply line. A shut-off valve should be installed in the line before the brewer. Install a regulator in the line when pressure is greater than 90 psi (620 kPa) to reduce it to 50 psi (345 kPa). The water inlet fitting on the strainer is 1/4" flare. **Verify that Strainer and Orifice are installed. (Fig. 3)**

**NOTE:** Bunn-O-Matic recommends 1/4" copper tubing for installations of less than 25 feet and 3/8" for more than 25 feet from the 1/2" water supply line. A tight coil of copper tubing in the water line will facilitate moving the brewer to clean the countertop. Bunn-O-Matic does not recommend the use of a saddle valve to install the brewer. The size and shape of the hole made in the supply line by this type of device may restrict water flow.

**As directed in the International Plumbing Code of the International Code Council and the Food Code Manual of the Food and Drug Administration (FDA), this equipment must be installed with adequate backflow prevention to comply with federal, state and local codes. For models installed outside the U.S.A., you must comply with the applicable Plumbing /Sanitation Code for your area.**

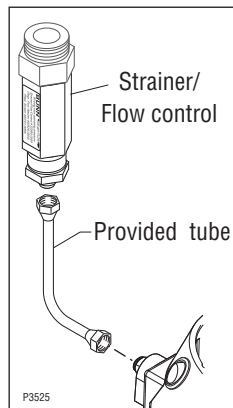

230V

FIG. 3 Strainer and Orifice Location 120V

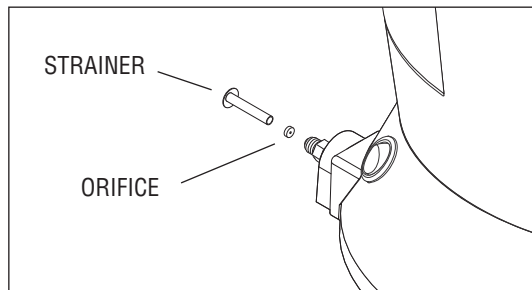

120V

## INITIAL BREWER SET-UP (MCP/MCPA)

- 1 Remove Slide Lid (A) and Water Reservoir (N)

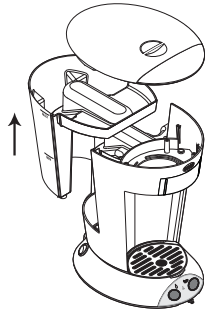

- 4 Plug in the brewer and turn on the Power Switch (M).

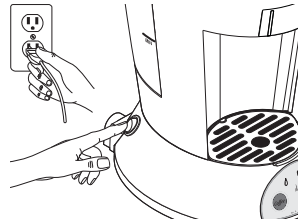

**NOTE:** The "Refill Water Indicator" will slowly flash until initial setup is complete.

- 2 Thoroughly rinse the Water Reservoir then fill to the MAX line.

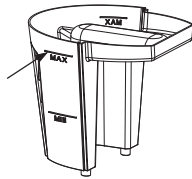

**NOTE:** Filling the Water Reservoir is not required for Automatic units with water line installed.

- 5 Press the Pod Holder Release Button (B) and pull the Pod Holder (F) out. Rinse thoroughly and reinstall.

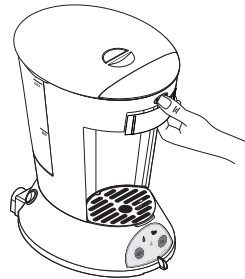

**CAUTION:** Always verify the Pod Holder is locked into place before brewing.

**CAUTION:** Do not attempt to remove the Pod Holder while brewing.

- 3 Reinstall the Water Reservoir.

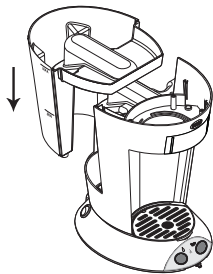

- 6 Place a cup that will hold a minimum of 14 oz. onto the Drip Tray Grate (G).

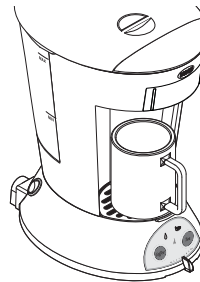

**CONTINUED**  
11

## INITIAL BREWER SET-UP (MCP/MCPA)

- 7 Fill the Primer Bulb (O) with water by squeezing the bulb while in the Water Reservoir.\*

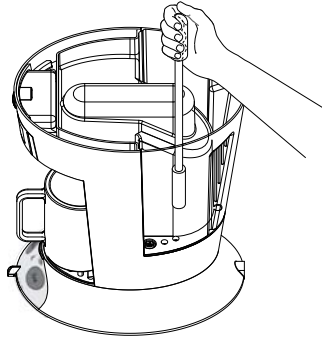

\*NOTE: Filling the Water Reservoir by pressing the "Coffee Brew Button" once will be required for Automatic units prior to completing Step 7.

NOTE: Squeezing the bulb with the whole hand rather than just the finger tips will give better results.

- 8 Place the tip of the "Primer Bulb" over the Water Reservoir Exit.

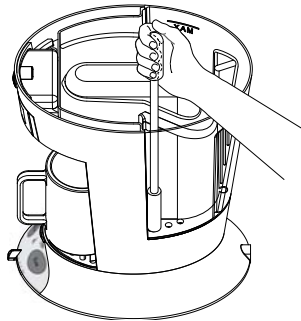

- 9 Press the "Coffee Brew Button" while applying a small amount of downward pressure on the "Primer Bulb" then squeeze to dispense the water from the bulb. Raise the "Primer Bulb" from the Water Reservoir Exit to allow the internal water pump to pull water from the Water Reservoir.

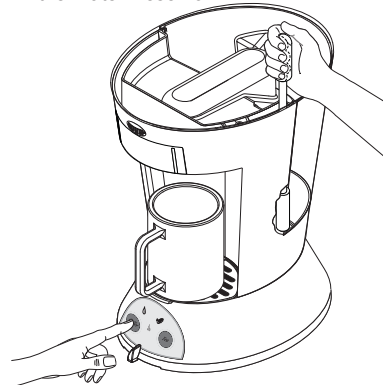

NOTE: Repeat Step 7 & 8 until the unit is primed, i.e. water is dispensing from the Pod Holder into the cup.

- 10 If the "Refill Water Indicator" is no longer flashing the initial setup is complete. Wait for the "Heating Indicator" to go out before brewing a fresh cup.

## BREWING DELICIOUS COFFEE OR TEA



### WARNING:

- \* Never place hands directly under pod holder outlet. Hot water can be present.
- \* Never remove the holder with force. If stuck, wait 10 minutes and try again.
- \* Never brew without the pod holder insert in place.

1. Check water level. Must be above MIN line.

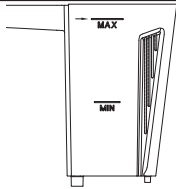

6. Insert the loaded pod holder into the brewer and press all the way in to lock holder.

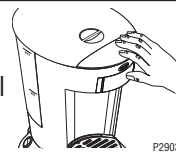

2. Adjust the volume control lever to the desired volume.

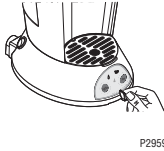

7. Press and release the Coffee or Tea button. To cancel a brew, press and release the Coffee or Tea button.

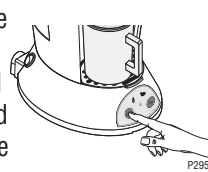

NOTE: Minimum volume is approx. 4 oz. (118 ml) Maximum is approx. 12 oz. (355 ml) Settings are in 1 oz. (30 ml) increments. Volumes are approximate and may vary with type and size of pod.

3. Place a mug, several ounces larger than the volume selected, on the drip tray grate below the pod holder.

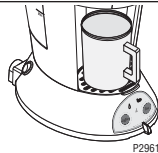

8. When brewing has stopped, press and hold the pod holder release button while sliding the pod holder out.

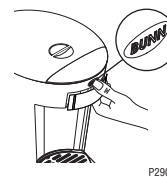

**CAUTION:** Hot water and hot pod will be present.

**NOTE:** The red BUNN light will come back on indicating the brew cycle has finished.

4. Press and hold the pod holder release button while sliding the pod holder out.

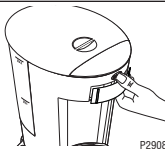

9. Dispose of the used pod. **Do Not Touch Hot Pod!**

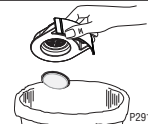

5. Press a pod into the pod holder. **NOTE:** For best results, center pod in holder and gently press the pod completely into holder cavity.

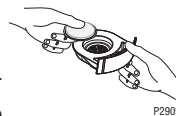

**Enjoy!**  
**(Caution: Beverage is very hot.)**

## ROUTINE CLEANING

**Before beginning any cleaning procedure, unplug the brewer to avoid the accidental start of a brew cycle.**

Clean the pod holder, drip tray and drip tray grate after each use, using a damp cloth and mild detergent and rinse. With the pod holder and drip tray removed, use a damp cloth with mild detergent to wipe the area below the pod holder and into the drip tray area. Occasionally, wipe the outside of the brewer with a damp cloth. (The reservoir, slide lid, pod holder, drip tray and drip tray grate are dishwasher safe.)

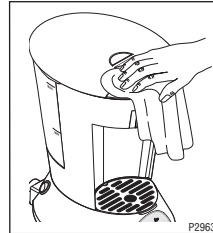

## PERIODIC CLEANING/DESCALING

**(Recommended At Least Once a Month.)**

Periodically, you should clean and descale the brewer to clear any mineral deposits that may have accumulated due to impurities in the water source. If these deposits are not removed, they can impair the operation of the brewer and reduce the product life.

There are several products available specifically for descaling. We recommend using URNEX® Activated Descaler or JavaClean2 Cleaner and Descaler, available on our web site: [www.bunn.com](http://www.bunn.com). (White vinegar can be used to descale if a descaling product is not available.)

**Follow the directions as printed on the manufacturer's package.**

- 1) Fill the reservoir with descaling product as described by the manufacturer's directions, or 32 oz. (946 ml) of white vinegar. **Do not add powder mix directly to the reservoir. Descaling product must be mixed into a solution before it is added to the reservoir.**
- 2) Place an empty pod holder into the brewer. Be sure the holder is locked into place, and set the VOLUME CONTROL SLIDE LEVER to the maximum position.
- 3) Place an empty container or bowl on the drip tray grate that will hold at least 14 oz. (414 ml) of liquid, and press the COFFEE BREW BUTTON to start a brew cycle.
- 4) Once the brew cycle has finished, empty the container and set it back onto the drip tray grate. Press the COFFEE BREW BUTTON again to start a second brew cycle.
- 5) Once the brew cycle has finished, empty the container and the remaining solution, or vinegar from the reservoir. Remove the pod holder; clean the reservoir and pod holder thoroughly using a mild detergent, then rinse.

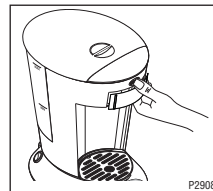
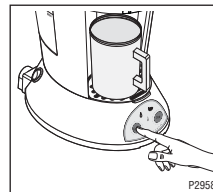
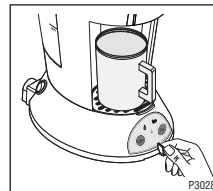

**NOTE:** There is now descaling solution in the internal tank. Follow the manufacturer's directions if the solution must be left in the tank for any period of time. For vinegar, allow the solution to sit for at least two, but no more than four hours.

- 6) Fill the reservoir to the "MAX" line with fresh clean cold water and place the pod holder back into the brewer.

**CONTINUED**

- 7) Place the empty container back onto the drip tray grate and press the COFFEE BREW BUTTON to begin a brew cycle.
- 8) When the cycle has finished, empty the container. Repeat step 7 at least two more times to remove the solution from the tank.
- 9) Clean the pod holder with a mild detergent and rinse thoroughly.
- 10) Proceed to the "Cleaning The Sprayhead/Seal" section.

### CLEANING THE SPRAYHEAD/SEAL



- 1) Press the Power Switch into the off "O" position.
- 2) Unplug the brewer and allow it to cool down. (Minimum of 1 hour.)
- 3) After the unit has been allowed to cool, remove the pod holder and set aside.
- 4) Using your fingers, rotate the sprayhead/seal assembly until the sprayhead and seal are removed.

**NOTE:** If the sprayhead and seal are separated, they must be reassembled as they were when removed from the brewer. **Improper reassembly could result in personal injury from scalding water.**

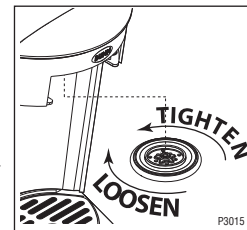

- 5) Clean the sprayhead and seal with a mild detergent and rinse thoroughly.
- 6) Using your fingers, rotate the sprayhead/seal assembly counter-clockwise until it is finger tight.
- 7) Replace the pod holder.
- 8) Plug in the brewer and press the Power Switch to restore power to the brewer.

### ASSEMBLING THE SPRAYHEAD/SEAL



If the sprayhead and seal are separated during removal or cleaning, they must be reassembled properly.

- 1) Identify the top of the seal. The top of the seal that seats against the roof of the sprayhead cavity has a ridge that can be felt by running your fingers across the surface of the seal. The bottom is smooth.
- 2) Identify the top of the sprayhead. The top of the sprayhead has a star pattern and a threaded hole where the sprayhead attaches to the brewer.
- 3) While carefully stretching the seal, guide the sprayhead into the channel of the seal. Make sure it is completely in the channel.

When properly assembled, the sprayhead will slide easily into the channel of the seal and will not cause any buckles in the surface of the seal. If the sprayhead seems to be difficult to seat, and you must stretch the seal more than a slight tug, the assembly is not together correctly.

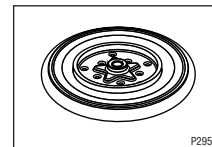
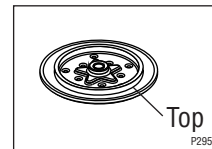
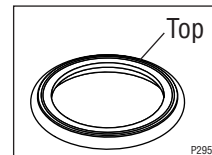

### INSPECTING THE SPRAYHEAD SEAL



When disassembling your brewer for cleaning, inspect the sprayhead seal for cracks, tears and holes. Although the seal should last for an extended period of time, damage can occur through handling.

**CAUTION:** *The seal confines the hot liquid to the pod holder. Replace the seal if it becomes damaged. Parts are available at [www.bunn.com](http://www.bunn.com).*

### CLEANING THE POD HOLDER

To prevent residue build up, it is a good idea to periodically disassemble the pod holder/screen assembly and clean it with a mild detergent.

- 1) Press and hold the POD RELEASE BUTTON while sliding the pod holder out.
- 2) Flip the POD HOLDER upside down and place the holder cavity over the palm of your hand.
- 3) Using a small object, press the tab of the POD HOLDER INSERT through the hole in the bottom of the pod holder to remove.
- 4) Clean the screen and holder using a mild detergent and rinse. (Dishwasher Safe)
- 5) Press the insert back through the hole in the bottom of the POD HOLDER.

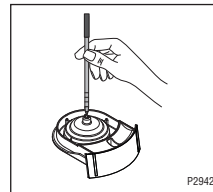

**WARNING:** *Brewing without the insert can result in hot liquid splash and burns.*

### CYCLING THE BREWER

If the brewer has not been used for an extended period of time, it is a good idea to cycle your brewer before brewing a serving of coffee or tea.

- 1) Remove the reservoir and pod holder from the brewer, clean with a mild detergent and rinse.
- 2) Refill the reservoir to the maximum line.
- 3) Insert an empty pod holder into the brewer. (Make sure it locks in place)
- 4) Set the volume control lever to the maximum setting.
- 5) Place a container on the drip tray grate that will hold at least 14 oz. (414 ml)
- 6) Press the coffee brew button.
- 7) When the brew cycle has ended and water drip out has stopped, carefully remove the pod holder and remove any excess water. You are now ready to brew.

**CAUTION:** *Water is hot!*

### STORING THE BREWER

Unplug the brewer and wait for it to cool. If your Pod brewer has been used, it must be stored above 32°F (0°C) to prevent damage to the internal water tank. Empty and dry the water reservoir before storing.

**NOTE:** *Water will remain in the internal tank. If stored for an extended period of time, refer to "Cycling The Brewer" section before using.*





## TROUBLESHOOTING



SITUATION	EXPLANATION
<b>The REFILL WATER INDICATOR has come on.</b>	<p><b><i>Pour-Over only:</i></b> <i>The WATER RESERVOIR has run low on water.</i></p> <p>Slide the lid open and pour additional water into the reservoir, or remove the reservoir and fill it at a sink, or other water source.</p> <p><b><i>CAUTION:</i></b> <i>Do not place the brewer in a sink or other water source. Do not fill past the Maximum fill line.</i></p> <p><b><i>Automatic only:</i></b> <i>The WATER RESERVOIR has recently been removed from the brewer and replaced empty.</i></p> <p>Press the Coffee or Tea brew button to activate filling of the water reservoir.</p> <p><b><i>CAUTION:</i></b> <i>To avoid accidental burns, always have a cup on the drip tray grate when pressing either brew button. Do not place hands under the pod holder outlet.</i></p>
<b>The POD HOLDER INDICATOR has come on.</b>	<p><i>The POD HOLDER is missing.</i></p> <p>Place the pod holder into the machine and press it firmly into place.</p> <p><i>The POD HOLDER is not locked in place.</i></p> <p>Carefully remove and re-insert the pod holder into the machine making certain it is locked into place. The POD HOLDER INDICATOR on the control panel will go out.</p>
<b>The water shuts off and comes back on again when brewing.</b>	<p><i>The TEA BREW BUTTON has been pressed to start the brew cycle.</i></p> <p><b>Do NOT press the TEA BREW or COFFEE BREW button during the brew cycle. This will stop the brew cycle.</b> The brewer is using a Pulse Brew™ technology to steep tea properly. The water will shut off and turn on</p>

(Continued)

### TROUBLESHOOTING (Cont.)

<b>SITUATION</b>	<b>EXPLANATION</b>
<b>(Continued)</b> <b>The water shuts off and comes back on again when brewing.</b>	again. This is normal and will take about 45 seconds to complete. Wait for the blue lights to go out. <b>NOTE:</b> <i>Although the pulse brew process can be used for coffee or tea, it is designed to brew tea. Because the process of brewing tea is different than coffee, the brewer works differently when the TEA BREW BUTTON is used. An “On-Off-On” cycle is used to steep the tea and provide the maximum flavor extraction. This is normal.</i>
<b>The Pod Holder will not come out of the brewer.</b>	<i>The pod in the POD HOLDER may have swelled to a point where the holder does not slide out easily.</i> Wait at least 10 minutes and then try carefully removing the pod holder again. <b>CAUTION:</b> <i>Hot liquid may be present.</i>
<b>Water is appearing on the counter around the base of the brewer.</b>	<i>The WATER RESERVOIR has been removed to be filled with water and was not seated properly when it was replaced.</i> Remove the lid from the top of the brewer. With firm, but not forceful pressure, press down on both sides of the reservoir to ensure that the seal in the bottom of the reservoir seats properly. Replace the lid and watch for additional water around the base of the brewer. If a problem persists, contact Customer Service. (Refer to page 18 for customer assistance.)
<b>Water leaks out around the sprayhead.</b>	<i>Replace a damaged seal or tighten a loose sprayhead.</i> Refer to “Assembling The Sprayhead/Seal” & “Inspecting The Sprayhead/Seal” sections for detailed information on how to resolve sprayhead leaks. <b>CAUTION:</b> <i>Wait for hot liquid to cool.</i>

**TROUBLESHOOTING (Cont.)**

<b>SITUATION</b>	<b>EXPLANATION</b>
<b>The BUNN® (POD HOLDER RELEASE BUTTON) indicator is not on all of the time.</b>	<p><i>When the BUNN® button (Also known as the POD HOLDER RELEASE BUTTON) is lit, this indicates that the power to the machine is on.</i></p> <p>No action is required. The BUNN® Pod brewer is ready to brew.</p> <p><i>When the brewer enters a sleep mode the POD HOLDER BUTTON will not be glowing.</i></p> <p>Pressing any button or the POD HOLDER RELEASE BUTTON will wake up the brewer.</p> <p><b>NOTE:</b> <i>If the brewer does not operate, refer to the first situation listed in the beginning of this troubleshooting section, on page 14.</i></p>
<b>The HEATING INDICATOR comes on when the COFFEE or TEA button is pressed.</b>	<p><i>The HEATING INDICATOR will glow when the tank is bringing water up to brew temperature.</i></p> <p>Wait for the HEATING INDICATOR to go out. When the Indicator has gone out, a brew cycle can be started.</p>
<b>The HEATING INDICATOR comes on during a brew cycle.</b>	<p><i>The water entering the internal tank is being heated for the next brew cycle.</i></p> <p>No action is required. As the heated water is being emptied to brew a serving, new water enters the internal tank. The brewer senses this new water and activates the tank heater to heat the water for the next brew cycle. The indicator coming on during a brew cycle is normal.</p>

## LIMITED WARRANTY

Bunn-O-Matic Corp. ("Bunn") warrants the Pod brewing equipment manufactured by it will be commercially free of defects in material and workmanship existing at the time of manufacture and appearing within 1 year of the date of purchase. The warranty covers both parts and labor for the 1 year period. This warranty does not apply to any equipment, component or part that was not manufactured by Bunn or that, in Bunn's judgment, has been affected by misuse, neglect, alteration, improper installation or operation, improper maintenance or repair, non periodic cleaning and descaling, equipment failures related to poor water quality, damage or casualty. In addition, the warranty does not apply to replacement of items subject to normal use: These items include but are not limited to; user replaceable parts such as seals and gaskets. This warranty is conditioned on the Buyer contacting Bunn for instructions on obtaining warranty service.

Contact may be made by:

- 1) Calling toll free 800-870-0894
- 2) World Wide Web [www.bunn.com](http://www.bunn.com)
- 3) In writing to us at Bunn-O-Matic Corp., Attn. Warranty Administrator, P.O. Box 3227, Springfield, IL 62708-3227

Upon receipt of the request for warranty service, Bunn at its sole option may choose to replace the unit, request that the unit be taken to a local Bunn Service center for repairs or request the unit be mailed pre paid to a Bunn repair center for repairs.

Prior authorization from Bunn is required for any warranty service and Bunn may request proof of purchase.

THE FOREGOING WARRANTY IS EXCLUSIVE AND IS IN LIEU OF ANY OTHER WARRANTY, WRITTEN OR ORAL, EXPRESS OR IMPLIED, INCLUDING, BUT NOT LIMITED TO, ANY IMPLIED WARRANTY OF EITHER MERCHANTABILITY OR FITNESS FOR A PARTICULAR PURPOSE. The agents, dealers or employees of Bunn are not authorized to make modifications to this warranty or to make additional warranties that are binding on Bunn. Accordingly, statements by such individuals, whether oral or written, do not constitute warranties and should not be relied upon.

If Bunn determines in its sole discretion that the equipment does not conform to warranty, Bunn, at its exclusive option while the equipment is under warranty, shall either 1) provide at no charge replacement parts and/or labor (during the applicable parts and labor warranty periods specified above) to repair the defective components, provided that this repair is done by a Bunn Authorized Service Representative; or 2) shall replace the equipment or refund the purchase price for the equipment.

THE BUYER'S REMEDY AGAINST BUNN FOR THE BREACH OF ANY OBLIGATION ARISING OUT OF THE SALE OF THIS EQUIPMENT, WHETHER DERIVED FROM WARRANTY OR OTHERWISE, SHALL BE LIMITED, AT BUNN'S SOLE OPTION AS SPECIFIED HEREIN, TO REPAIR OR REPLACEMENT.

In no event shall Bunn be liable for any other damage or loss, including, but not limited to, lost profits, lost sales, loss of use of equipment, claims of Buyer's customers, cost of capital, cost of down time, cost of substitute equipment, facilities or services, or any other special, incidental or consequential damages.



**NOTES:**



# USER SERVICEABLE PARTS

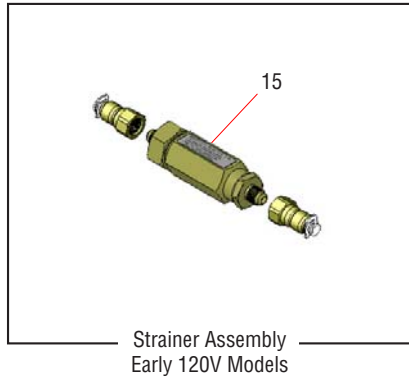
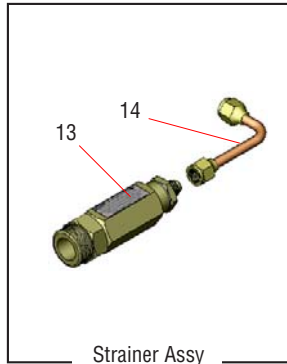
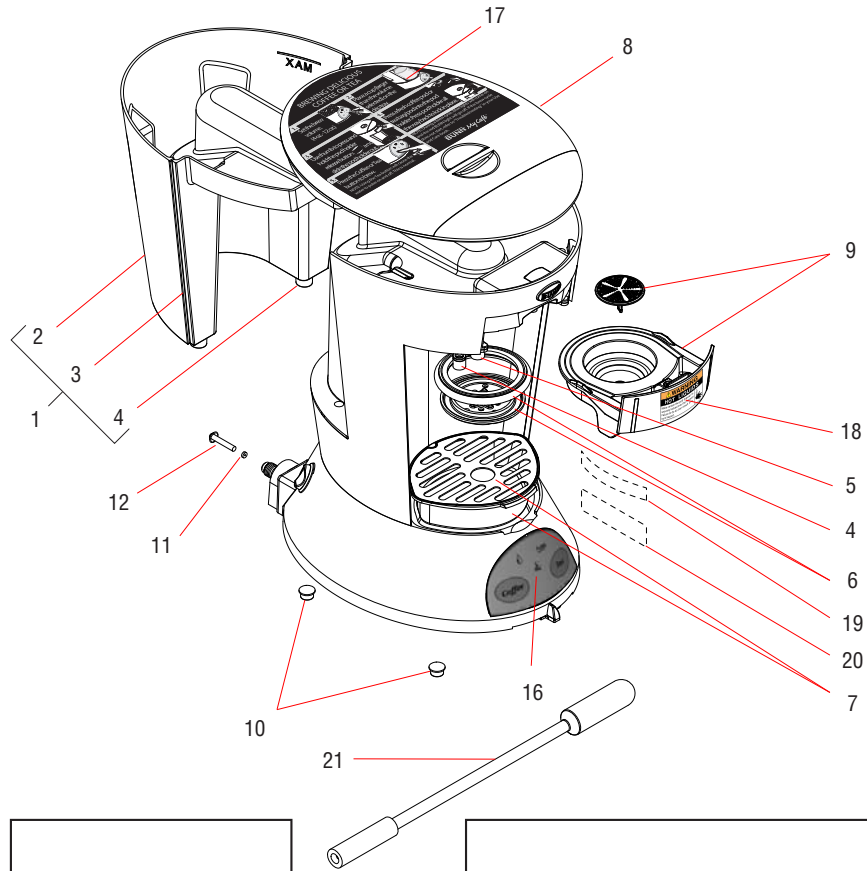

## USER SERVICEABLE PARTS

1	37419.1000	1	Reservoir Assy, Float/Valve
2	36264.0000	1	Reservoir, 46 Oz
3	39446.0000	1	Guide/Float Assy
4	36378.0001	2	Valve, Check DW 10
5	36379.0000	1	Valve, Check DW 11
6	37521.0000	1	Kit, Sprayhead/Seal Assembly
7	37520.0000	1	Drip Tray & Grate Assy (MCP)
	37520.0001	1	Drip Tray & Grate Assy MCA)
8	37495.1000	1	Lid Assy, Pour-In (Includes Decals)
9	36717.1002	1	Pod Holder Assembly BLK
	36717.1003	1	Pod Holder Assembly BLU
10	34466.0000	5	Foot, Rubber .5" OD x .25"
11	39182.0000	1	Orifice, Inlet Tube 120V
12	39216.0000	1	Screen Filter 120V
13	38414.0000	1	Strainer/Flow Control Assy 230V
14	00310.0000	1	Tube Assembly, 230V
15	22300.0222	1	Strainer/Flow Control Assy (Early Models)
16	36891.0000	1	Decal, Control Panel (MCA)
	36534.0000	1	Decal, Control Panel (MCP)
17	37092.0001	1	Decal, Removable 5-Step
18	41936.0000	1	Decal, WARNING: HOT LIQUIDS
19	37282.0000	1	Decal, TO CANCEL BREW....
20	37092.0001	1	Decal, MY CAFÉ
21	44941.1000	1	Bulb, Priming