

Important Safeguards

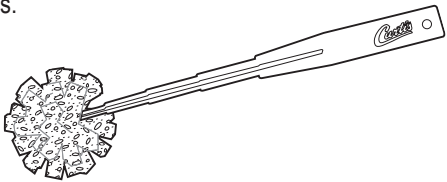

CAUTION: Failure to follow the instructions can result in injury or the voiding of the warranty.

- Do NOT immerse the unit in water or any other liquid.
- Leave a 1¼" space from the brim of the airpot when filling to prevent overflow.
- Maintain distance from direct heat around stoves and hot surfaces.
- Keep hands and other items away from hot parts of unit during operation of brewer.
- Never clean with scouring powders or harsh cleaners containing chlorine.
- Do NOT use scrub brush or coarse pad to clean inside the liner. We recommend the JB-1 brush, available from Curtis.



Specifications

TLXA0101S000 One Gallon Airpot

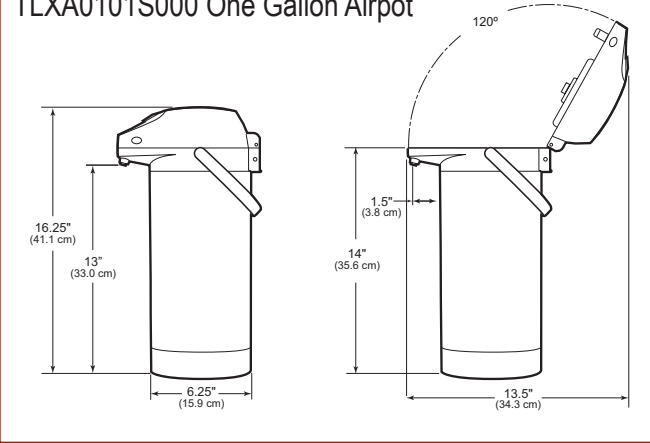

- *Brew-through Stopper*
- *1 Gallon (3.8 Liter) Capacity*
- *Orange Decaf Sticker*
- *Keeps Liquids Hot or Cold for Up to 10 Hours*

Curtis[®]

Instructions

1
GALLON

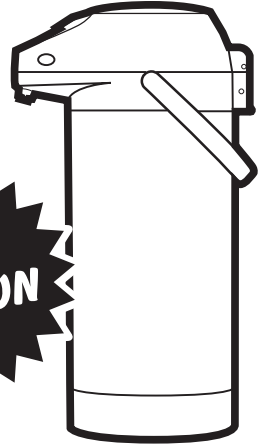

THERMOPRO AIRPOT MODEL TLXA0101S000

Curtis[®]

WILBUR CURTIS CO., INC.

6913 Acco St., Montebello, CA 90640-5403 USA

Phone: 800/421-6150 ♦ Fax: 323-837-2410

♦ Technical Support Phone: 800/995-0417 (M-F 5:30A - 4:00P PST) ♦ E-Mail: techsupport@wilburcurtis.com

♦ Web Site: www.wilburcurtis.com

FOR THE LATEST SPECIFICATION INFORMATION
GO TO WWW.WILBURCURTIS.COM

Instructions

To open the lid:

- Move the carrying handle to the back of the airpot.
- Squeeze in the two lock buttons on both sides of the lid and lift backwards.
- Remove the stopper and fill to 1¼" from the mouth of the liner. Return the stopper and close the lid.



IMPORTANT: To avoid temperature drop when first brewing coffee into the airpot, preheating the airpot is recommended. Fill the airpot with hot water for a moment, just to warm the liner. Empty the hot water, then brew.

Using an airpot brewer:

- When brewing for the first time, set the brew time with the stopper removed so you can observe the brew volume. Once volume is set, you may brew through the stopper.
- Because the orifice on the stopper is small, take care when centering under the brewer.
- Close the lid. Lid should snap closed.

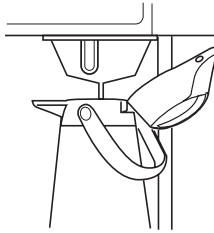

To dispense coffee:

- Lift the lever arm high enough to engage the safety prop that holds the lever arm the pumping position.
- Pump the lever arm to dispense.

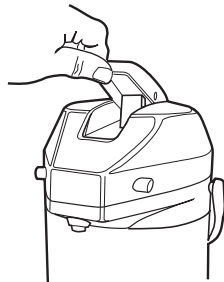

Cleaning

- Clean with warm water and dishwashing detergent.
- Use a sponge cleaning brush to scrub inside.
- Rinse thoroughly with hot water.



CAUTION

Do not immerse in water. Do not place in dishwasher. Do not use harsh powders or cleansers containing chlorine.

Troubleshooting

- Contents will not flow when pumped. Things to check:

- Is there adequate liquid volume in the airpot.
- Is the stopper properly inserted?
- Is there a tight fit at the stopper gasket?
- Is the lever handle being pumped with enough force?
- Is the suction pipe of the stopper assembly clogged.
- Has the rotating bottom cover loosened. A leak in air pressure may cause insufficient suction.

Parts List, 1 Gallon Airpot

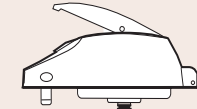

1
Lid & Lever Assembly

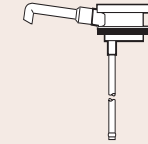

2
Stopper Assembly

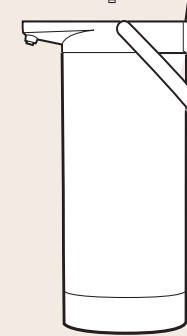

Index N ^o	Part N ^o	Description
1	WC-5672	LID & LEVER ASSEMBLY BLACK
1A	WC-5670	LID & LEVER ASSEMBLY ORANGE DECAF
2	WC-56017	STOPPER ASSY, 1 GALLON